

FILTERS

FOR ELECTRIC DISCHARGE MACHINES AND WATER TREATMENT SYSTEMS



Efficient filtration saves your costs

FILTERS - type STANDARD

Photo		Item. No.	Machine	Dimensions Permeability	Filtr. area [m ²]	Flow direction	Specification
		H15190/16	Agie Charmilles	Øout 150mm Øin 31mm Height 375mm 5µm	3,73	from out to in	AM, AGIE CUT, CLASSIC, CHALLENGE, PROGRESSS, VERTEX EVOLUTION, DEM ACH CUT 1000-3000 ROBOFIL(100-6020)
		SW-02	Japax Sodick Seibu Amada	Øout 150mm Øin 34mm Height 345mm 5µm	2,318	from out to in	AT, EXP, L series W,WA,A,AP,Gseries EW, EWP series WP
		SW-17	Mitsubishi	Øout 260mm Øin 29mm Height 340mm 5µm	5,408	from out to in	N, DWC Series
		SW-17A	Hitachi	Øout 260mm Øin 37mm Height 340mm 5µm	5,408	from out to in	H-Cut 304
		SW-20	Mitsubishi Brother	Øout 300mm Øin 29mm Height 500mm 5µm	10,537	from in to out	DWCF, G, H series HS300, 350
		SW-23	Hitachi Japax Sodick	Øout 260mm Øin 37mm Height 280mm 5µm	4,448	from out to in	PW 500B JL, LXH, LA A, AW, AP, EPOC
		SW-23A	Makino	Øout 260mm Øin 46mm Height 280mm 5µm	4,448	from out to in	EC, EA

FILTERS - type STANDARD

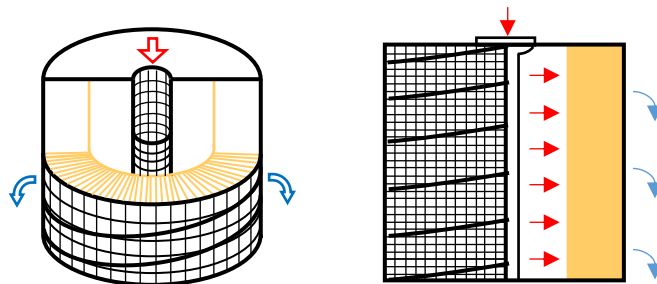





Photo		Item No.	Machine	Dimensions Permeability	Filtr. area [m ²]	Flow direction	Specification
		SW-26	Hitachi	Øout 300mm Øin 46mm Height 340mm 5µm	7,152	from in to out	H-Cut 34, 406 Series
		SW-27	Brother	Øout 260mm Øin 46mm Height 400mm 5µm		from in to out	HS-100
		SW-37	Fanuc Japax Sodick Charmilles	Øout 340mm Øin 46mm Height 450mm 5µm	10,304	from in to out	O,P,Q,W series JL20,30,55 A,HA,BF series Robofil 230, 240, Robofil 440
		SW-01	Charmilles Seibu	Øout 150mm Øin 31mm Height 370mm 5µm		from out to in	Old series Old series
		V23 OTO	EIR 002-005	Øout 135mm Øin 83mm Height 155mm			002-005

FINE FILTERS for EDM wire cutters, EDM hole drillers and water treatment systems.

PHOTO	MACHINE	DIMENSIONS Permeability
 Item No.: SF-02 SF-01 SF-05 without grooves with grooves wound type	Agie Charmilles Hitachi Makino Water treatment systems	\varnothing_{out} 65mm \varnothing_{in} 28mm Height 250mm 5 μ m
 Item No.: SF-03 SF-04 without grooves with grooves	Agie Charmilles	\varnothing_{out} 65mm \varnothing_{in} 28mm Height 122mm 5 μ m
Item No.: JF-AU Fine filter with compressed activated carbon 	Designed for water treatment systems	\varnothing_{out} 65mm \varnothing_{in} 28mm Height 250mm 10 μ m
Item No.: MFRO/UV1 Reverse osmosis membrane filter for water treatment systems 	Designed for water treatment systems	\varnothing_{out} 76mm Height 298mm

Information about delivery of other types of filters are available on request.

Filter tank for one filter H15190/16



Item No.: FN1H15
 Filter tank for one filter H15190/16

Stainless filter tank with filter H15190/16 serves as replacement for small filters SF type in EDM hole driller's filtration part. Using a large filter H15190/16 increases the lifetime and filter replacement interval in hole drilling EDM. Filter tank is suitable for using in older EDM, which had not suitably solved filtration system or where are not more available original filters.

FILTERS - type DUAL

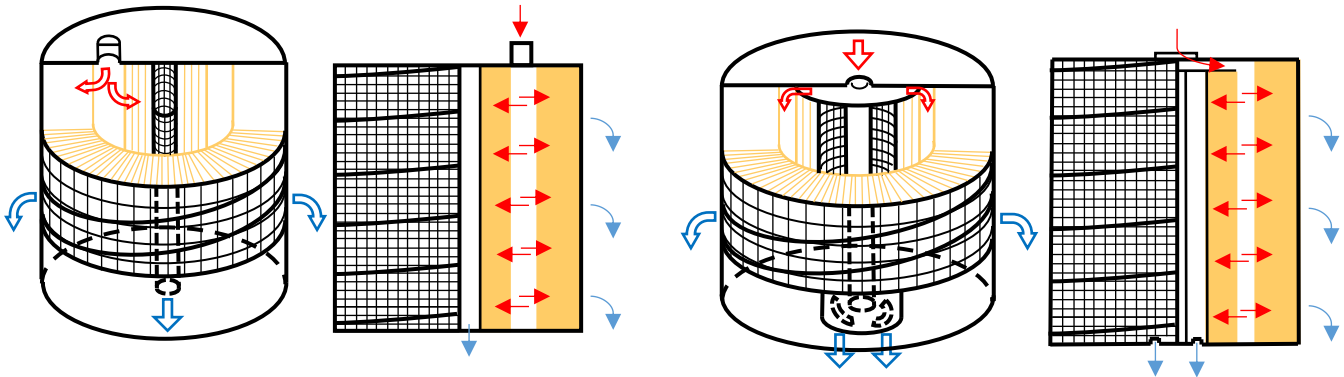

Photo		Item. No.	Machine	Dimensions Permeability	Filtr. area [m ²]	Flow direc- tion	Coupler	Specification
		SW-40	Makino Mitsubishi Seibu Hitachi Accutex Excetek SPM	Øout 300mm Øin 59mm Height 500mm 5µm	14,521	from in to out	Connector Type B with connect. thread G1/2" out of center	EE, EH, EQ, EC, MU DWC-90B, 110A A, K2 series Q-series, 203 Accutex Excetek SPM
		SW-41	Mitsubishi Brother	Øout 300mm Øin 29mm Height 250mm 5µm	7,438	from in to out	No connector is used	DWC, F, G, H HA, SX HS300-5100
		SW-42	Fanuc Japax Sodick Charmilles	Øout 340mm Øin 46mm Height 300mm 5µm	13,815	from in to out	No connector is used	O,P,Q,W,α series JL 20, 30, 55 A,AG,AQ,BF,SL,VL series Rfi 230,240,440CC
		SW-43	Mitsubishi Makino Hitachi	Øout 340mm Øin 46mm Height 300mm 5µm	13,981	from in to out	Connector Type B with connect. thread G1/2" out of center	CX, FX, K, FA, MV series U32,53,U3,U6,DUO Cut355,254R,254Y 203
		SW-43-1	Fanuc	Øout 340mm Height 300mm 5µm	13,981	from in to out	Included connector Type A with connect. thread G3/4" out of center	α-0iB , 1iB α-0iC , 1iC α-0iD , 1iD α-0iE , 1iE α-CiA, CiB series

FILTERS - type DUAL

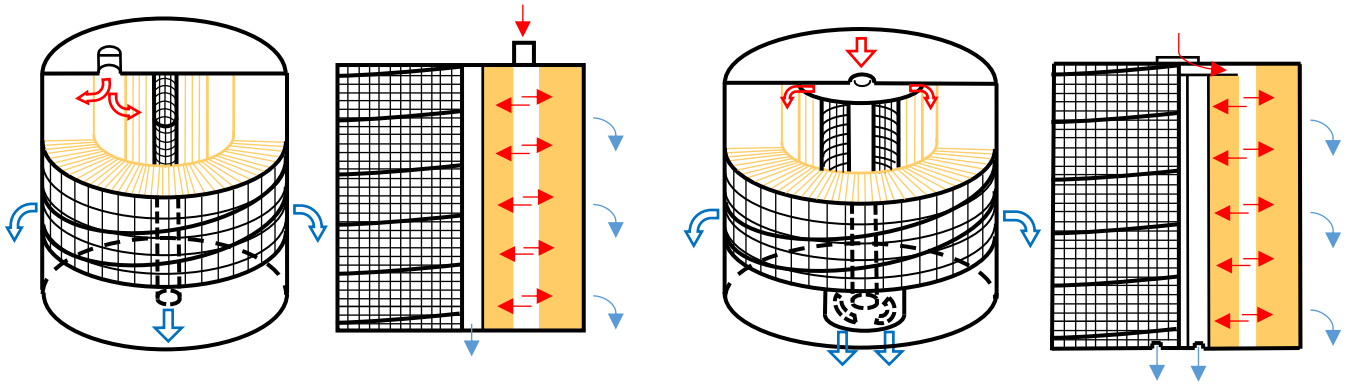



Photo		Item. No.	Machine	Dimensions Permeability	Filtr. area [m ²]	Flow direc- tion	Coupler	Specification
		SW-45	Mitsubishi Makino Seibu	Øout 300mm Øin 29mm Height 300mm 5µm	9,238	from in to out	Connector Type B with connect. thread G1/2" out of center	DWC B, Z, P, A EE, L, Q, H, MU A,K 2 series
		SW-46	Mitsubishi Makino Hitachi Seibu	Øout 300mm Øin 29mm Height 250mm 5µm	10,304	from in to out	Connector Type B with connect. thread G1/2" out of center	EC, ECO, PF

FILTERS - type OMF

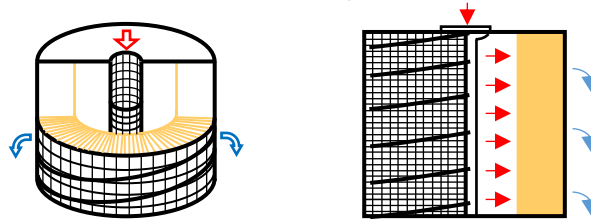

Photo		Item. No.	Machine	Dimensions Permeability	Filtr. area [m ²]	Flow dire- ction	Coupler	Specification
		OMF-250A	Mitsubishi Brother Hitachi	Øout 300mm Øin 29mm Height 250mm 5µm	5,75	from in to out	No connector is used	DWC F,G,H,C SX SX series HS-300,350, 3100,3600 H-Cut 304,406,460
		OMF-250AK	Mitsubishi Makino Hitachi	Øout 300mm Height 250mm 5µm	5,75	from in to out	Connector Type B with connect. thread G1/2'' in the center	DWCB,A,SA,Z,ZP SZ, SZP, PA EE,EQ,EH,EQH Q series H-Cut-Q
		OMF-500A	Mitsubishi Brother Hitachi	Øout 300mm Øin 29mm Height 500mm 5µm	10,58	from in to out	No connector is used	DWC, C1,C2 HS-300, 350 3100, 3600 H-Cut 406,460
		OMF-500AK	Mitsubishi Makino Hitachi Seibu Accutex	Øout 300mm Height 500mm 5µm	10,58	from in to out	Connector Type B with connect. thread G1/2'' in the center	DWC-110PA EE,EQ,EQH Q-series H-Cut-Q EW-A5, A5S C3 Accutex
		OMF-340F	Sodick Fanuc Charmilles	Øout 340mm Øin 46mm Height 300mm 5µm	13,815	from in to out	No connector is used	A,AG,AQ,BF,SL,VL series O,P,Q,W1,2,3 α-0B, 1B, 0C, 1C Robofil 440CC
		OMF-340FK	Mitsubishi Makino Hitachi Seibu	Øout 340mm Height 300mm 5µm	9,047	from in to out	Connector Type B with connect. thread G1/2'' in the center	CX,FX,FA, MV ser. EQF,MUQ, EC,ECQ Cut series EW-A5, A5S, C3
		OMF-340FK-1	Fanuc	Øout 340mm Height 300mm 5µm	9,047	from in to out	Connector Type A with connect. thread G3/4'' in the center	α-0iB , 1iB α-0iC , 1iC α-0iD , 1iD α-0iE , 1iE α-CiA, CiB series

FILTERS - type SUPER

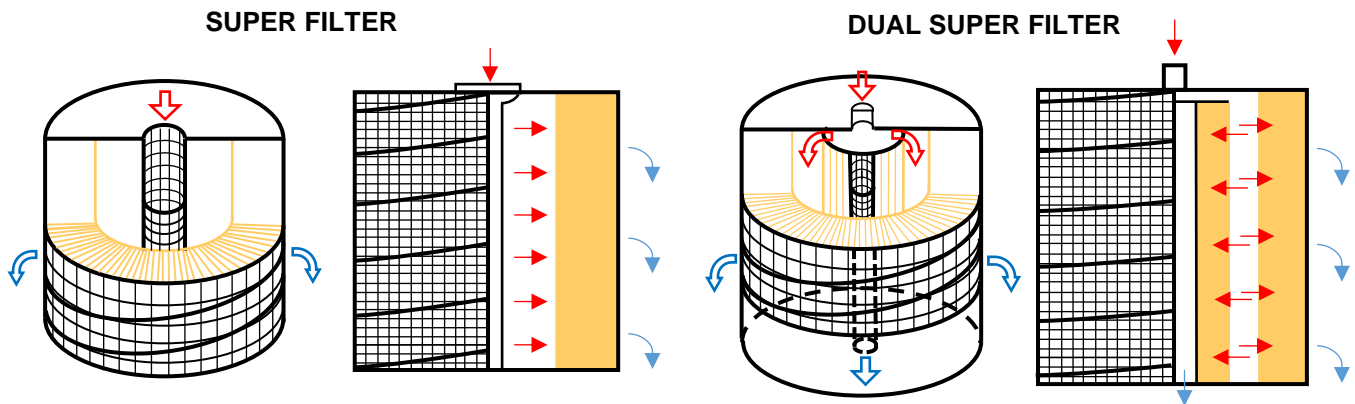

Photo	Item. No.	Machine	Dimensions Permeability	Filtr. area [m ²]	Flow direction	Coupler	Specification
	Super 250A	Mitsubishi Brother Hitachi	∅out 300mm ∅in 29mm Height 250mm 5μm	8,0	from in to out	No connector is used	DWC F,G,H,C SX SX series HS-300,350, 3100,3600 H-Cut 304,406,460
	Super 250AK	Mitsubishi Makino Hitachi	∅out 300mm Height 250mm 5μm	8,0	from in to out	Connector Type B with connect. thread G1/2'' in the center	DWCB,A,SA,Z,P SZ, SZP, PA EE,EQ,EH,EQH Q series H-Cut-Q
	Super 500A	Mitsubishi Brother Hitachi	∅out 300mm ∅in 29mm Height 500mm 5μm	16,0	from in to out	No connector is used	DWC, C1,C2 HS-300, 350 3100, 3600 H-Cut 406,460
	Super 500AK	Mitsubishi Makino Hitachi Seibu Accutex	∅out 300mm Height 500mm 5μm	16,0	from in to out	Connector Type B with connect. thread G1/2'' in the center	DWC-110PA EE,EQ,EQH Q-series H-Cut-Q EW-A5, A5S C3 Accutex
	Super 340F	Sodick Fanuc Charmilles	∅out 340mm ∅in 46mm Height 300mm 5μm	14,4	from in to out	No connector is used	A,AG,AQ,BF,SL,VL series O,P,Q,W1,2,3 α-0B, 1B, 0C, 1C Rfl 230,240,440CC

FILTRE - typ SUPER

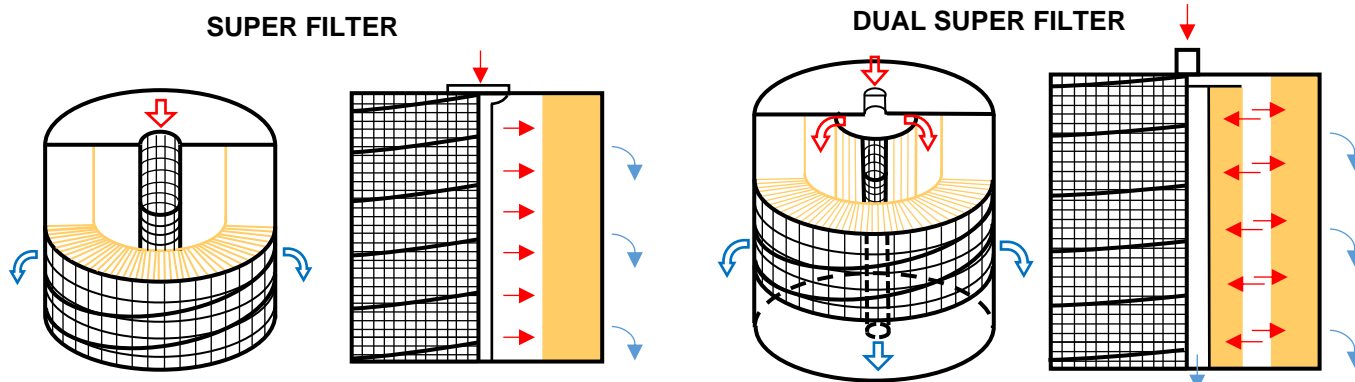











Photo		Item. No.	Machine	Dimensions Permeability	Filtr. area [m ²]	Flow direction	Coupler	Specification
		Super 340FK	Mitsubishi Makino Hitachi Seibu	Øout 340mm Height 300mm 5µm	14,4	from in to out	Connector Type B with connect. thread G1/2'' in the center	CX,FX,FA,MV serie EQF,MUQ, EC,ECQ Cut series EW-A5, A5S, C3
		Super 340FK-1	Fanuc	Øout 340mm Height 300mm 5µm	14,4	from in to out	Connector Type A with connect. thread G3/4'' in the center	α-0iB , 1iB α-0iC , 1iC α-0iD , 1iD α-0iE , 1iE
		Super 340C (Dual Super Filter)	Charmilles Fanuc	Øout 340mm Height 450mm 5µm	21,84	from in to out	Connector Type A with connect. thread G3/4'' in the center	Robofil 240, 440SL CC-series CUT20,30,200,300 CUT400, E,P-series Robocut CiA, CiB series
		Super 340CS	Charmilles Fanuc	Øvonk. 340mm Výška 450mm 5µm	15,80	z vnút. na von.	Connector Type A with connect. thread G3/4'' in the center	Robofil 240, 440SL CC-series CUT20,30,200,300 CUT400, E,P-series Robocut CiA, CiB series
		Super 340M (Dual Super Filter)	Mitsubishi Seibu	Øout 340mm Height 450mm 5µm	21,84	from in to out	Connector Type B with connect. thread G1/2'' in the center	FA Series EW-A5,A5S,C3 series

Information about delivery of other types of filters are available on request.

FILTERS - type OIL

Photo	Item. No.	Machine	Dimensions Permeability	Filtr. area [m ²]	Flow direction	Specification
	SO-04	Agie Charmilles	Øout 150mm Øin 31mm Height 360mm 10µm	2,318	from out to in	AgieTron, Agie Eloxmondo AgieTronintegral Roboform, Eleroda
	SO-04M	Agie Charmilles	Øout 150mm Øin 31mm Height 360mm 10µm	2,318	from in to out	AgieTron, Agie Eloxmondo AgieTronintegral Roboform, Eleroda
	SO-08	Japax Sodick	Øout 260mm Øin 37mm Height 280mm 10µm	4,448	from out to in	DH, DXC80NC, DP-40 D-100M, DX 40NC, AC, AR, AH, EPOC, AP
	SO-09	Makino	Øout 260mm Øin 46mm Height 280mm 10µm	4,448	from out to in	EDNC series
	SO-10	Hitachi	Øout 260mm Øin 37mm Height 340mm 10µm	5,408	from out to in	HABM, HEMS
	SO-12	Makino Japax Seibu Sodick	Øout 150mm Øin 72mm Height 450mm 10µm	2,796	from out to in	ED22 DP,ADX,JX,DX,DXC,DXW E,EM,M NC,AC,AP,AR,BM,EPOC,FP
	SO-16	Mitsubishi	Øout 260mm Øin 29mm Height 340mm 10µm	5,408	from out to in	DK, DM, DX, DP

FILTERS - type OIL

Photo	Item. No.	Machine	Dimensions Permeability	Filtration area [m ²]	Flow direction	Specification
	SO-18	Hitachi	Øout 150mm Øin 34mm Height 350mm 10µm	2,234	from out to in	D, EMS, H, KE, ED
	SO-18M	Mitsubishi	Øout 150mm Øin 34mm Height 350mm 10µm		from in to out	M, DK-140
	SO-24	Mitsubishi Sodick	Øout 260mm Øin 29mm Height 340mm 10µm	5,408	from in to out	M series, J, V, DP A, AH, AD, AM, AG, K series,
	SO-34	Hitachi	Øout 300mm Øin 46mm Height 340mm 10µm	6,219	from in to out	H, PSD, DSIO, DS20
	SO-36	Mitsubishi	Øout 300mm Øin 59mm Height 500mm 10µm	13,147	from in to out	K, KS, S, W, M series
	SO-42 (dual filter)	Mitsubishi	Øout 300mm Øin 46mm Height 330mm 10µm	8,659	from in to out Connector Type C with connect. thread G1/2" out of center	EX, VX series
	SO-300FK	Mitsubishi	Øout 300mm Height 300mm 10µm	4,320	from in to out Connector Type C with connect. thread G1/2" in the center	EA series, EDM drillers

FILTERS - type OIL

Photo	Item. No.	Machine	Dimensions Permeability	Filtration area [m ²]	Flow direction	Specification
	FL5	Charmilles Exeron Ingersoll Zimmer-Kreim Agie	Øout 150mm Øin 32mm Height 368mm 5µm		from out to in	Roboform series, FORM X,S,P,E series EDM series Gantry series Genius series Erosion EDM-Layer type
	FL5/2	AEG	Øout 150mm Øin 32mm Height 255mm 5µm		from out to in	Erosion EDM-Layer type
	SO-12A	Sodick	Øout 150mm Øin 35mm Height 450mm 10µm	2,796	from out to in	Old A series
	SO-12B	Erotech	Øout 150mm Øin 31mm Height 450mm 10µm	2,796	from out to in	Basic
	H15190/16	Agie Ingersoll Zimmer-Kreim Charmilles	Øout 150mm Øin 31mm Height 375mm 10µm	3,73	from out to in	Agie Tron, Hyperspark Gantry Genius FORM X,S,P,E series Drill 20

Information about delivery of other types of filters are available on request.

Connectors included with filters - free in the price of the filter

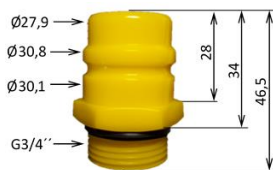

Type A

Plastic connector, included with filters SUPER 340C, SUPER 340CS, SW-43-1, OMF 340FK-1, SUPER 340FK-1, ...



Type B

Plastic connector, included with filters SW-40, SW-43, SW-45, SW-46, OMF 250AK, OMF 500AK, OMF 340FK, SUPER 250AK, SUPER 500AK, SUPER 340FK, ...



Type C

Steel connector, included with filters SO-42, SO-300FK, ...

Brass connectors for filters – for an extra charge

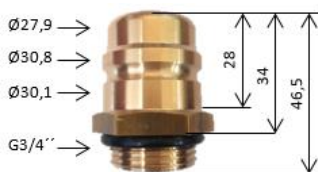

Type A

Item No.: FBCA – G3/4''

Brass connector for filters SUPER 340C, SUPER 340CS, SW-43-1, OMF 340FK-1, SUPER 340FK-1, ...



Type B

Item No.: FBCB – G1/2''

Brass connector for filters SW-40, SW-43, SW-45, SW-46, OMF 250AK, OMF 500AK, OMF 340FK, SUPER 250AK, SUPER 500AK, SUPER 340FK, ...

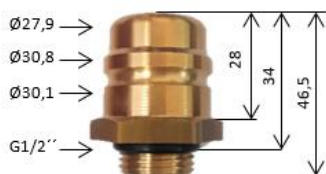

Type A – G1/2''

Item No.: FBCA – G1/2''

Brass connector Type A, for filters with connection thread G1/2''

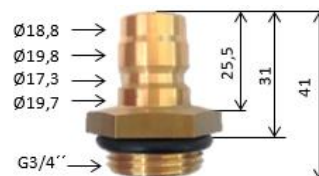

Type B – G3/4''

Item No.: FBCB – G3/4''

Brass connector Type B, for filters with connection thread G3/4''

Quick couplers for connectors of filters



Item No.: QCF

Quick coupling straight for connectors Type A



Item No.: QCS

Quick coupling straight for connectors Type B



Item No.: QCA

Quick coupling angle for connectors Type B



Item No.: QCBS

Quick coupling straight for connectors Type C

A diatomite – filling for the diatomite filters (description: white powder)



Filter material for air filtration to the electric generator cover

Item No.: **Filmat 13-20**

Filtration material of thickness 13-20mm, for air filtration to the electric generator cover

- Width of the roll 2000 mm x length we cut as required
- Can be ordered only in multiples of 2 m²
- Minimum order = 2000 mm x 1000 mm, i.e. 2 m²
- Better price when buying the whole role



Information about delivery of other types of filters are available on request.

FD1 Filtration a deionization device for EDM hole-drillers and other machines.

Item No.: FD1

Filtration a deionization device for EDM hole-drillers and other machines

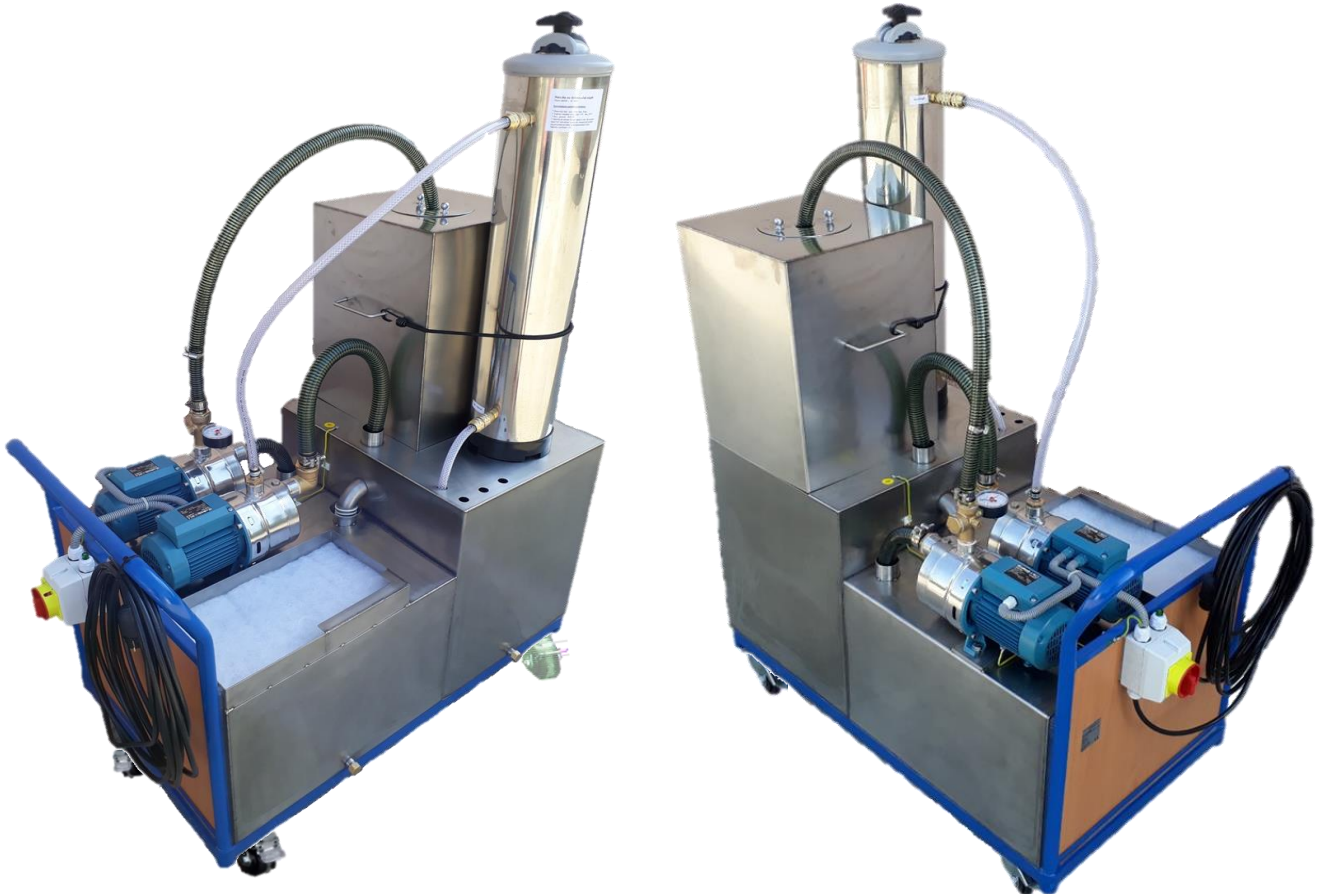

Dimension with container for ion exchange resin [LxWxH]:	1160x640x1620mm
Dimension without container for ion exchange resin [LxWxH]:	1160x640x1220mm
Water tank volumes clean filtered and deionized water / with used water / together:	120 l / 120 l / 240 l
Container for ion exchange resin volume:	20 l

Filter: 1x filter SUPER340C or SUPER 340CS, also possible to use lower height filters SW-43-1

Technical parameters of filters are on next page, in section 2, or on our web pages: <http://www.elero.sk/Filters.pdf>

Filtration medium: Distilled / demineralized water, or ordinary tap water

It is possible to produce the device without deionization, also for water with emulsion or for dielectric for die-sinking EDM

Power supply: 230V AC, 50Hz

Electric power input / electric power: 1300W / 900W

Electric power cable: 10m

Pumps have built-in idle protection

Notice:





Before pouring the water or other possible medium, disconnect device FD1 from electric power!

With electric installation and electric parts of device FD1, can only be handled by a person qualified to do so!

Accessories for FD1 filtration and deionization device for EDM hole-drillers and other machines.

Filters:

In FD1 filtration and deionization device for EDM hole-drillers and other machines are using the same filters - SUPER 340C or SUPER 340CS, which are using also in new EDM wire-cutters AGIE CHARMILLES, or FANUC.

Photo		Item No.	Machine	Dimensions Permeability	Filtrat. area m ²	Flow direct	Conne- ction	Specification
		Super340C (dual filter)	Charmilles Fanuc	Ø _{out.} 340mm Height 450mm 5µm	21,84	from out to in	Connector Type A with connect. thread G3/4" in the center	Robofil 240, 440SL CC-series CUT20,30,200,300 CUT400, E,P-series Robocut CiA, CiB series
		Super340CS	Charmilles Fanuc	Ø _{out.} 340mm Height 450mm 5µm	15,80	from out to in	Connector Type A with connect. thread G3/4" in the center	Robofil 240, 440SL CC-series CUT20,30,200,300 CUT400, E,P-series Robocut CiA, CiB series

Ion exchange resin:

Ion exchange resin is used for water treatment in FD1 filtration and deionization device for EDM hole-drillers and other machines. This makes the water nonconductive, i.e. deionized water. The quality of the ion exchange resin is important for the EDM hole-drilling process. Poor ion exchange resin quality will not sufficiently reduce the conductivity of the water, and thus allow partial discharge of the electric-charge from the electrode, through the water, to the working table of the machine and will reduce the drilling speed. We supply ion exchange resin of the highest quality.

Water conductivity can be quickly and easily measure with the digital waterproof conductometer DWCM.



Item No: DN/50/ELEION PLUS

Ion exchange resin ELEION PLUS extra-long life - barrel 50L

Item No.: DN/25/ELEION PLUS

Ion exchange resin ELEION PLUS extra-long life - bag 25L

Digital waterproof conductometer

Water conductivity in FD1 filtration and deionization device for EDM hole-drillers and other machines can be quickly and simply measured with hand-held digital conductometer.

Item No.: DWCM Digital waterproof conductometer
 - measuring range: 0-1999 µS/cm



Accessories for FD1 filtration and deionization device for EDM hole-drillers and other machines.

Filters – strainers for stainless container NDN/20S



Item No.: HFS-NDN

**Complete input filter-strainer for stainless
containers NDN/8S-20S**

Item No.: DFS-NDN

**Complete output filter-strainer for stainless
containers NDN/8S-20S**

Extended objects gripper

Item No.: EOG-NDN

**Extended objects gripper for output (lower) filter-strainer DFS-NDN mounting in stainless
containers for ion exchange resin NDN/8S-20S**

For simple manipulation with objects in deep and narrow space.
Adjustable length 80-120cm



Filtration material

Item No.: Filmat 13-20 **Filtration material of thickness 13-20mm**

- to filtration of coarse impurities on the hole of a lower tank for used water

- Width of the roll 2000 mm x length we cut as required
- Can be ordered only in multiples of 2 m²
- Minimum order = 2000 mm x 1000 mm, i.e. 2 m²
- Better price when buying the whole role

