

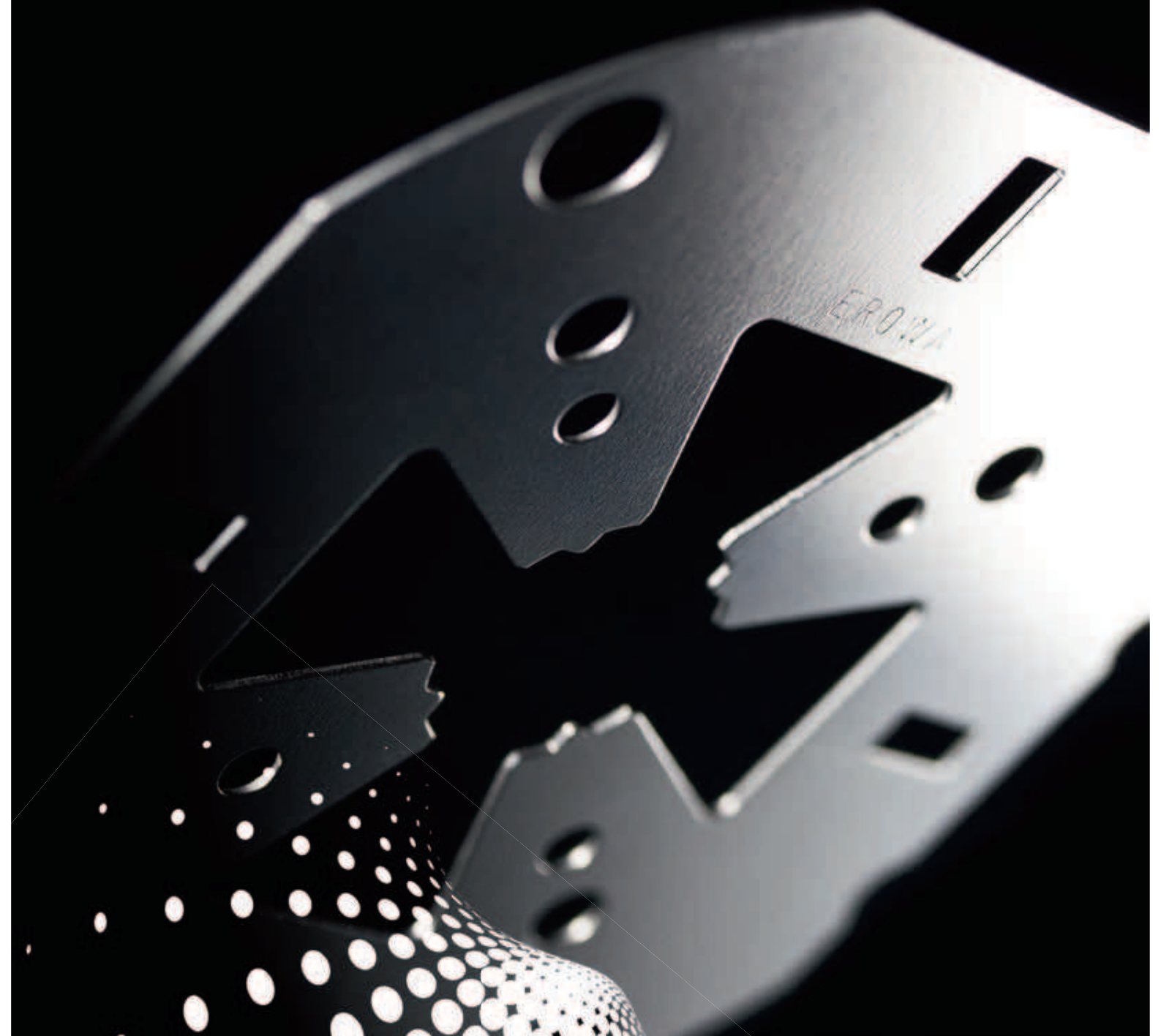

General Catalog

Unlocking the full potential
of your machines



EROWA UPC

You might as well try to move a mountain

EROWA's UPC (Universal Power Chuck) breaks through the conventional limits of precision, stability and workpiece size. Now, 500 x 500 x 500 mm have ceased to be a problem. And the 2- μ m precision will not be impaired at all.

A decisive factor for ITS users: the central ITS chuck guarantees seamless integration into the existing system.

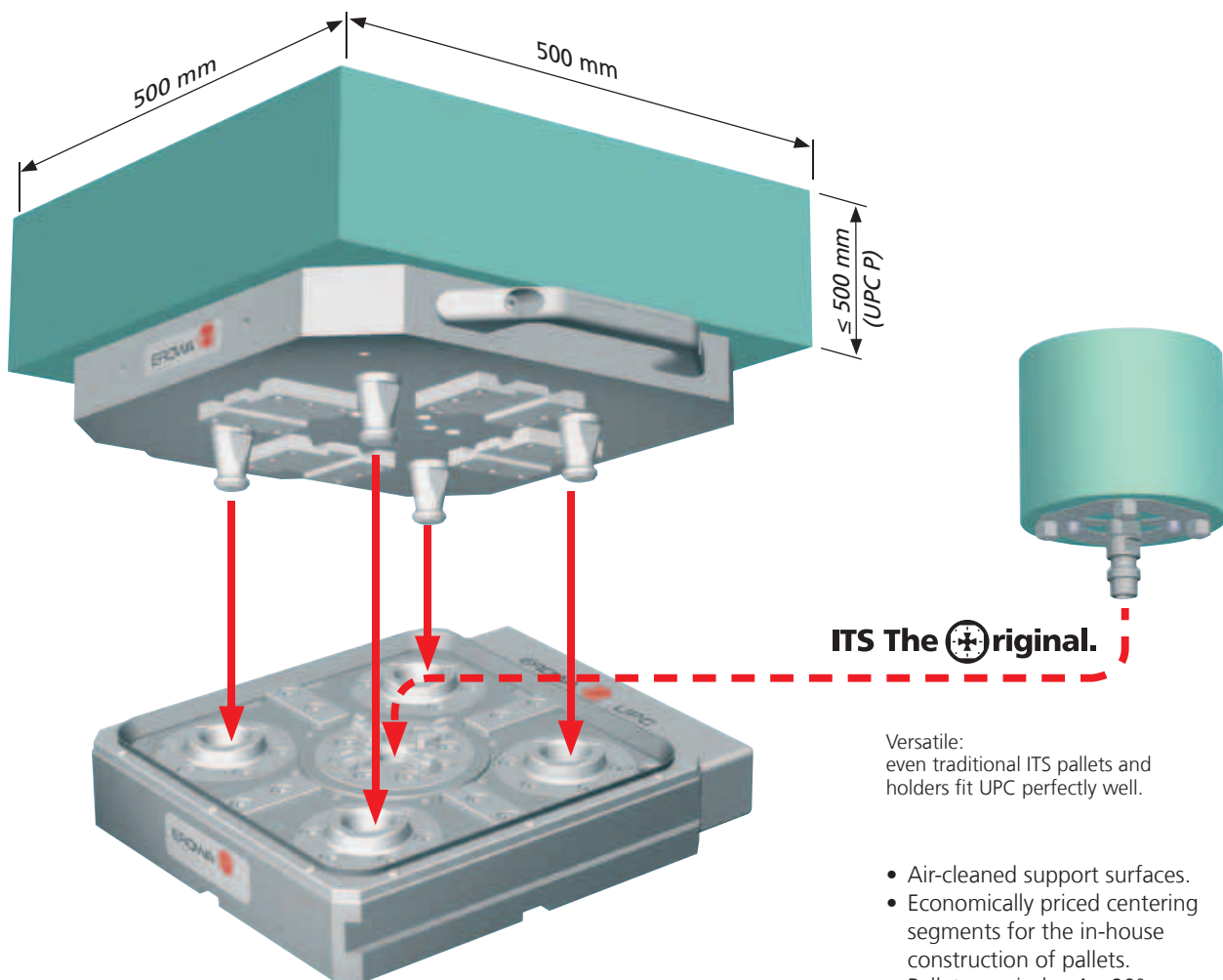

ITS The Original.

Versatile:
even traditional ITS pallets and
holders fit UPC perfectly well.

- Air-cleaned support surfaces.
- Economically priced centering segments for the in-house construction of pallets.
- Pallets can index 4 x 90°.
- Stable centering segments with patented initial tension.
- ITS chuck can be integrated in the center (option).
- Four fixed chucking spigots which also serve as supports for pallet storage.
- Economically priced aluminum pallets with hardened Z-supports as a basis for any fixture.

Applications**Handling**

Manual / Loading facility / Robot

Function

UPC open

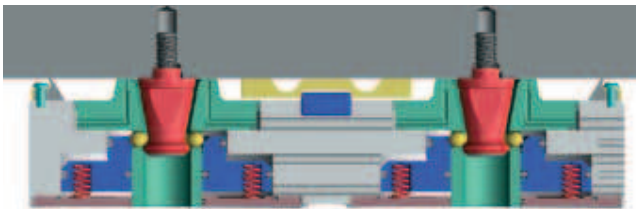

UPC closed

The functional elements have been designed with every conceivable simplicity. This makes for a favorable price. The few movable parts guarantee high functional safety.

The lock creates a retaining power of 50,000 N. The big distance between the supports creates an extreme degree of platform stability.

Precentering is done by means of the chucking spigots. Precise positioning is then achieved by four stable centering segments in the pallet and chuck. Release and cleaning are achieved by means of compressed air.

Technical data - UPC

	UPC	UPC P «Production»
Pallet size	320 x 320 mm	320 x 320 mm
Chuck dimensions	280 x 280 mm	320 x 300 mm
System height (chuck and pallet)	105 mm	105 mm
Recommended workpiece sizes	500 x 500 x 350 mm	500 x 500 x 500 mm
Repeatability	0.002 mm	0.002 mm
Indexation, pallet	4 x 90°	4 x 90°
Activation	clamped without pressure	
Air pressure, dry	min. 6 bar	min. 6 bar
Operation	manually or with automatic control unit	
Process monitoring	pneumatically, evaluation electro-pneumatically	
Clamping power	32,000 N	50,000 N

EROWA UPC in operation

Universal, powerful, micronaccurate

The UPC tooling system is suitable for flexible use. Whether big electrodes on the quill of EDM centers or big workpieces in milling machines: the UPC has been designed to cope with them, and it does.

With a repeatability of 2 μm , the UPC does not leave any wishes unfulfilled with regard to precision, either.

RELIABLE

Resistant to dirt.
Robust - developed for
continuous operation.

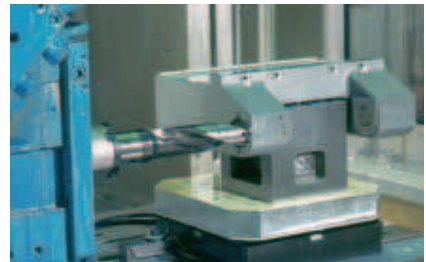
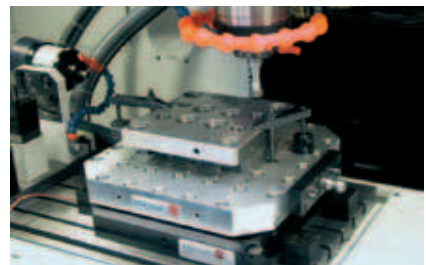
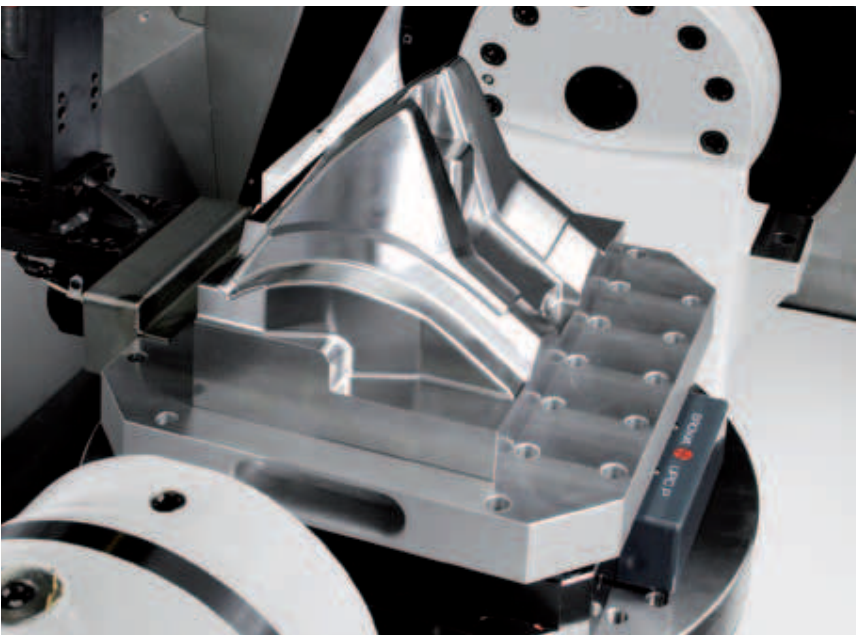

Customized solutions including. We'll be happy to advise you!

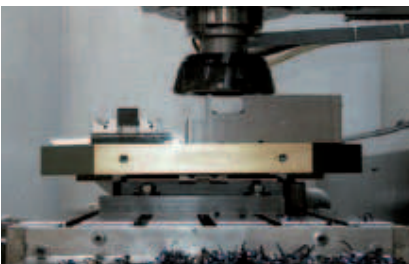

Low construction height leaves much room for workpieces.



Suitable PreSet stations are available for setting up and presetting - manual or CNC.

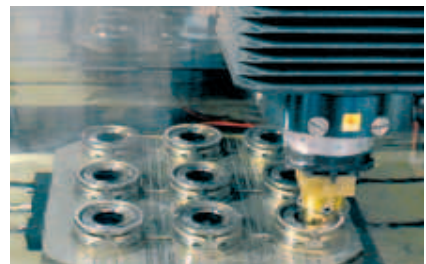

Practical! EDMing on the UPC magnet pallet.



On a clamping surface of up to 500 x 500mm, even large workpieces or fixtures can be attached to the UPC pallet without any problems.



Powerful in heavy machining.



2 in 1: UPC adapter pallet with EROWA PowerChuck P.



Flexible and modular. EROWA self-centering vise 148 on UPC pallet.



UPC Pallet Alu DG – light and handy.

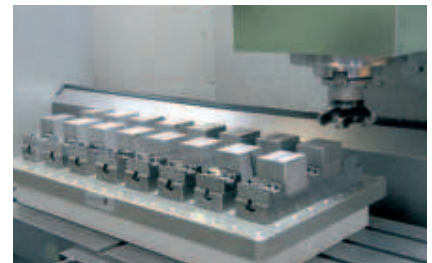

Short set-up times with flexible clamping elements: EROWA ClampSet vises on UPC grid pallet.



The UPC on the machine table constitutes the interface with the workpiece carrier. Resetting takes next to no time, and production can resume.



From a manual handling unit to a complex robot system - EROWA provides the handling solution that you desire.

EROWA UPC Palletizing System



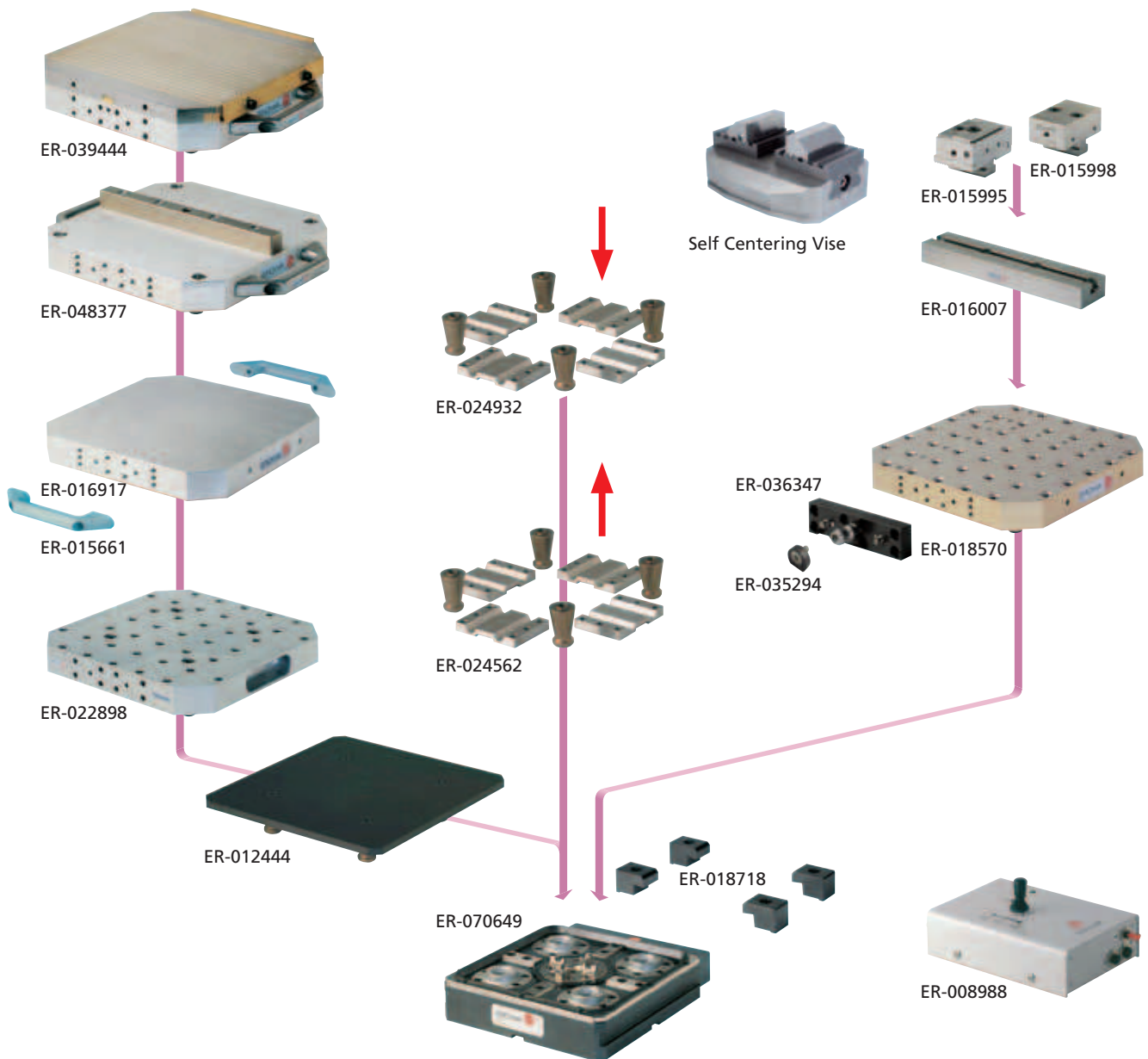



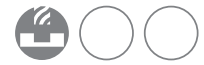









The components



To make it easier for you to find your way about the fields of application for EROWA products, we use the following symbols in all our documents:



EROWA UPC PALLETIZING SYSTEM

-  1. Manual operation
-  2. Operate with compressed air jet
-  3. Operate with manual valve
-  4. Operate with manual control unit
-  5. Operate with electro-pneumatic control unit
-  6. With central flushing clearance
-  7. Suited for submerged operation
-  8. Corrosion-resistant material
-  9. Suited for automatic operation
-  10. Handling with EROWA Robot gripper S
-  11. Handling with EROWA Combi gripper
-  12. Handling with EROWA Robot gripper 72
-  13. Handling with EROWA Robot gripper 115
-  14. Handling with EROWA Robot gripper 148
-  15. Handling with EROWA gripper RN PC 210
-  16. Handling with EROWA RCS gripper

UPC	chucks	58
UPC	pallets	59
UPC	auxiliary equipment	60



For chip-removing processes



For EDM sinking



For WEDM

EROWA UPC Chucks

Technical data	UPC	UPC P «Production»	ITS Chuck 100P	PowerChuck
Repeatability	0.002 mm	0.002 mm	0.002 mm	0.002 mm
Indexing, pallet position-oriented	4 x 90°	4 x 90°	4 x 90°	4 x 90°
Chuck clamping power	32,000 N	50,000 N	6000 N	10 000 N
Generated by	spring power	spring power	spring power	spring power
Chuck opens, air pressure dry	min. 6 bar	min. 6 bar	min. 6 bar	min. 6 bar

ER-074524 UPC chuck



Version UPC, prepared to accommodate an ITS chuck 100P.
 Connections On the side.
 Application On milling, grinding, drilling and EDM sinking centers.
 In production lines.

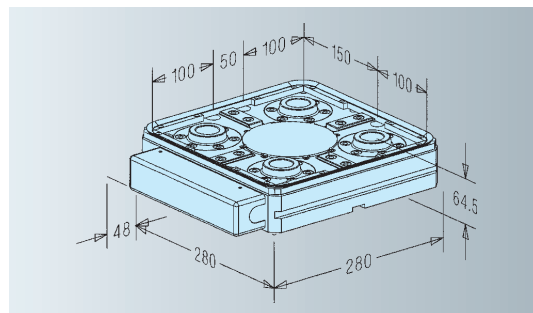

ER-070649 UPC chuck with ITS Chuck 100 P



Version UPC with ITS chuck 100P fitted and aligned.
 UPC system automatable.
 Connections On the side.
 Application On milling, grinding, drilling and EDM sinking centers.
 In production lines.

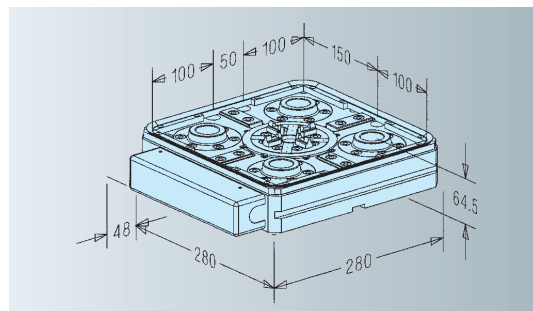

ER-016841 UPC P chuck



Version Chuck for high machining forces during chip removal.
 Connections Through the base and on the side.
 Application On milling, grinding, drilling and EDM centers.
 In production lines.
 Option UPC Sealing-Set ER-016650.

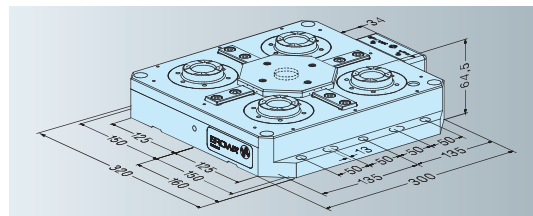

ER-030581 UPC P / PowerChuck P kit automatic



Version UPC P with air dock for the automatic operation of PowerChuck P.
 Content 1 x ER-028784, UPC P with air duct and UPC seal kit,
 1 x ER-030580, PowerChuck P on UPC pallet with air duct,
 1 x Pneumatic tube.
 Requirements *At least 4 air ducts available on the machine table.
 *Air ducts for the PowerChuck P are only possible laterally.
 If required, an adapter plate can be used.

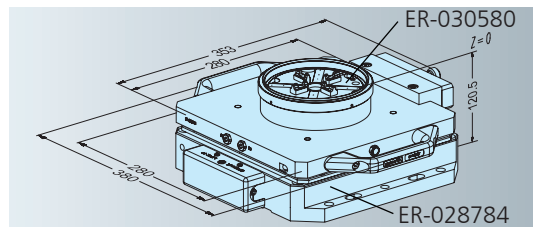

EROWA UPC

Pallets

ER-016917 UPC pallet Alu 320 x 320 x 40



Version Aluminum, with centering segments and chucking spigots fitted. Hard Z-support.

Application To clamp workpieces and gauges.

Please note Holes to be drilled as required.

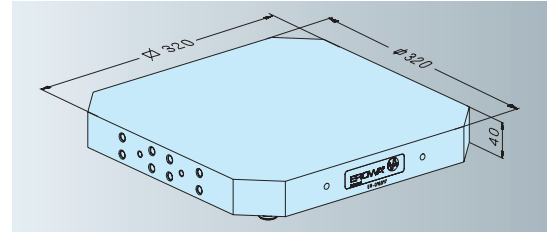

ER-018570 UPC pallet Alu R50 320 x 320 x 40 eloxed

ER-016003 UPC pallet Alu R50 320 x 320 x 40



Version Aluminum with 50mm grid. Centering segments and chucking spigots fitted. Hard Z-support.

Application Basis for gauges and workpieces.

Info Pattern borehole \varnothing 12F7, M12 thread.

Please note The elox version is not suited for use in EDM machines.

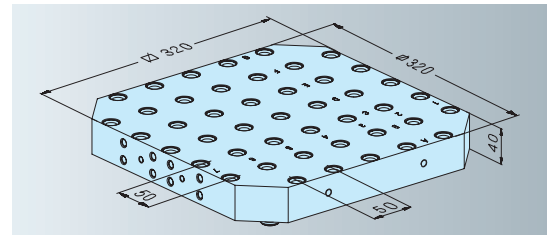

ER-022898 UPC pallet Alu diecast

ER-022896 UPC pallet Alu diecast S



Version Aluminum with 50mm grid. Chucking spigot fitted. Handles integrated. Steel Z-support.

Application To clamp workpieces and gauges.

Please note ER-022898: centering segment integrated in aluminum (repeatability: 0.005 mm).
ER-022896: with steel centering segment fitted (repeatability: 0.002 mm).

Accessories Order separately: ER-032503, M10 insert nut.

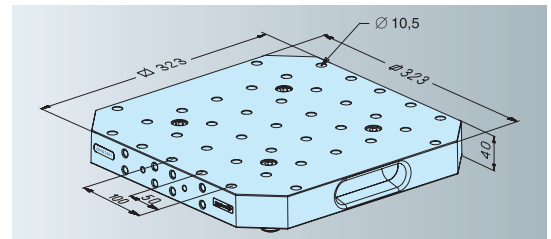

ER-039444 UPC magnet plate Neomicro



Version Magnet plate assembled as a UPC pallet 320 x 320 x 58 mm.

Application To clamp workpieces for surface and profile grinding, EDM sinking, and high speed milling.

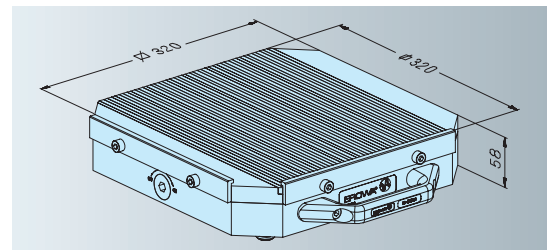

EROWA UPC

Auxiliary equipment

ER-024932 UPC centering segments and chucking spigots, for mounting from above



Version Four segments and chucking spigots for UPC, including bolts.

Application To produce special UPC pallets.

Mounting With bolts through the pallet from above.

Note Easy to assemble on the UPC chuck.

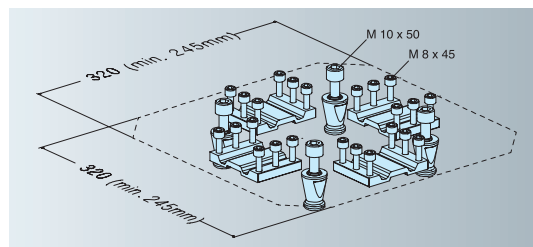

ER-024562 UPC centering segments and spigots to mount from lower side



Version Four segments and chucking spigots for UPC, including bolts.

Application To produce special UPC pallets.

Mounting With bolts through the pallet from below.

Note Easy to assemble on the PreSet Basic UPC presetting station.

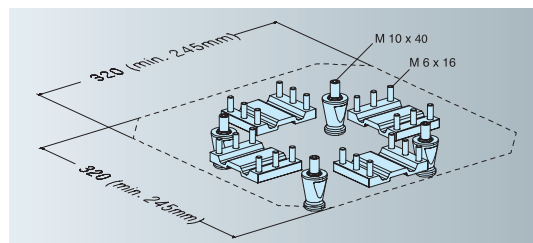

ER-048377 UPC alignment pallet



Application To align angular position and to determine the center of UPC chucks.

Please note System parallelism 0.005 mm.
Borehole concentricity 0.005 mm.

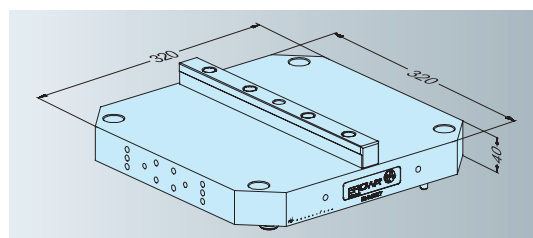

ER-029453 PowerChuck P on UPC pallet



Version Adapter pallet UPC - PowerChuck P.

Connections Laterally on pallet.

Application On machining centers. Operate with air-jet or fixed connection.

Note Manual change into UPC. Possible automatic change into PowerChuck P.

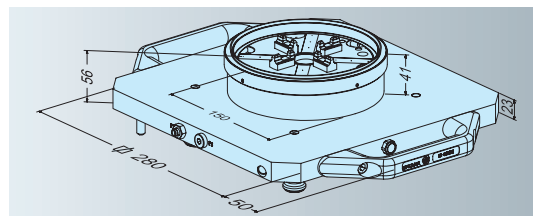

ER-008988 Manual control unit

- Version Manual valve to control all the functions of ITS, ITS Compact CombiChuck, PowerChuck P and UPC: opening/reclamping/cleaning.
- Application Operation of chucks on machines.

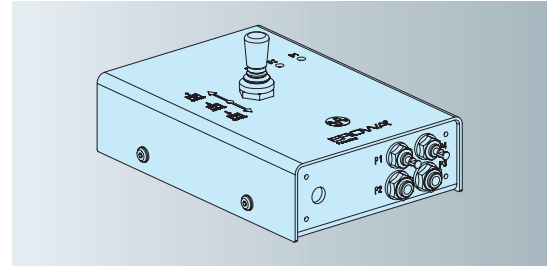
**ER-039466 Additional valve double**

- Version For mounting to the manual control units ER-008988 and ER-025893, incl. set of hoses.
- Application Operating of two separate chucks with one single control unit.

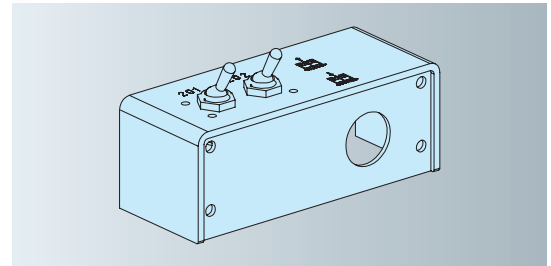
**ER-016531 UPC air jet connection**

- Version Valve for the manual operation of UPC ER-016092, ER-016093, ER-074527 and ER-070649 with an air jet.
- Application To be fitted on UPC cover.

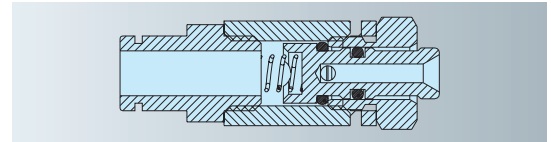
**ER-018168 UPC P air jet connection**

- Version Valve for the manual operation of UPC P ER-016841 with an air jet.
- Application To be fitted on UPC P cover.

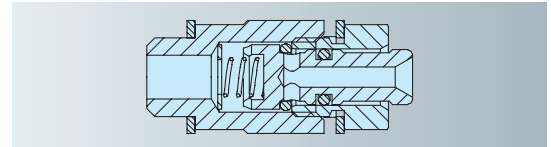
**ER-012444 Cover for UPC**

- Version Aluminum.
- Application Cover for UPC.

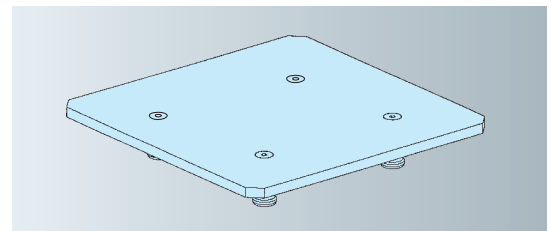

EROWA UPC

Auxiliary equipment

ER-012441 Cover set for UPC / ITS



Version Aluminum with inserts for 51, \varnothing 72, \varnothing 115, \varnothing 148 pallets and for electrode holders for UPC ER-016092.

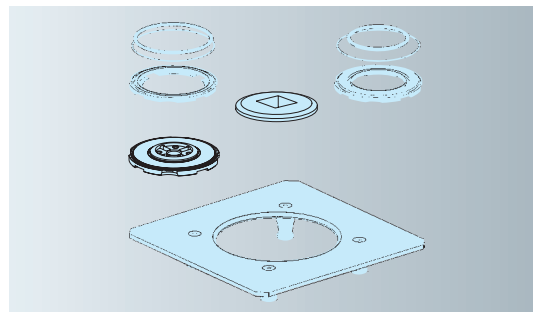

ER-018247 Cover UPC pallet \varnothing 148



Version Aluminum. Cover for UPC ER-016092.
Application Protects UPC system when \varnothing 148 mm pallets are used in the ITS central chuck.

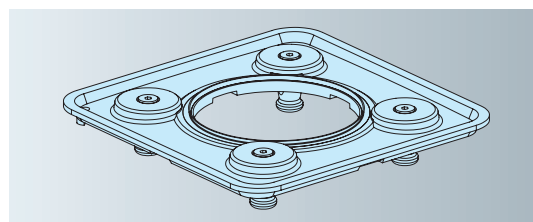

ER-016650 UPC sealing kit



Version Rubber seal and frame.
Application To seal the UPC P against chips.
Mounting With supplied bolts.
Please note Fits UPC No. ER-016092/ER-016093/ER-016841.

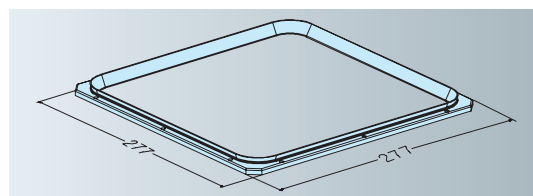

ER-018718 UPC clamping bracket 4 pieces



Version High tension steel, mounting accessories not included.
Application To mount UPC chucks to machine tables.
Please note Fits UPC chuck No. ER-016092/ER-016093/ ER-016841.

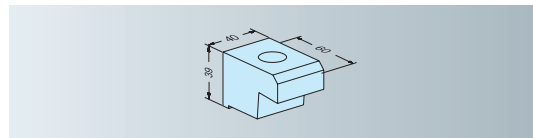

ER-015661 Handles for UPC pallets / FrameSet 2 pieces



Version Aluminum die-casting, set of 2 units.
Application Safe handles for UPC pallets.
Mounting With the enclosed bolts to the prepared threads.

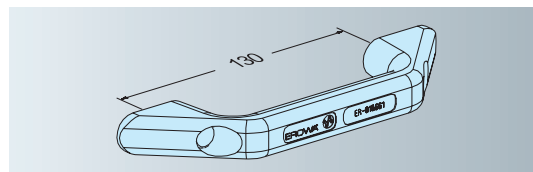

**ER-018817 Sealing bolt M12
50 pieces**

Version Set of 50, including square wrench.
Application Plastic bolts to seal grid boreholes that are not in use.
Suitable for ER-018570 and ER-016003.

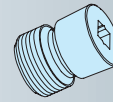
**ER-022646 Plug \varnothing 10.6 x 20
50 pieces**

Version Set of 50.
Application Plastic plug to seal grid boreholes that are not in use.
Suitable for ER-022898 and ER-022896.

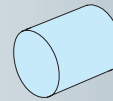
**ER-036347 GripperLink RCS / EWIS™ Rapid**

Version Coupling for UPC pallets, mounting accessories included.
Application Suited for UPC pallets to be used on EROWA handling devices with the «RCS coupling system».

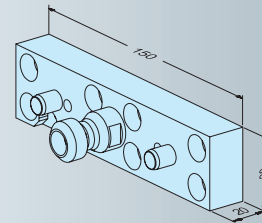
**ER-035294 EWIS™ Rapid chip with chip holder RCS
with chip \varnothing 12,4 x 2 mm**

Version Holder with built-in datacarrier.
EWIS chip: read only.
Application To build into RCS coupling, PalletSet W holder and Basic WEDM holder.



UPC

